



# Enclave Educativo

Mobiliario y equipamiento escolar

## HEXA

2336





- 1 Tablero de MDF  
MDF tabletop  
Plateau en MDF  
Tauler de MDF

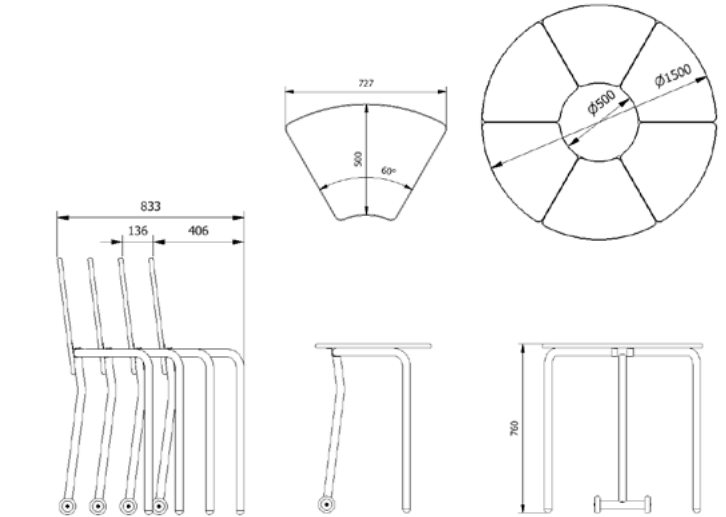

TALLA / SIZE / TAILLE / TALLA

4 - 5 - 6

COLOR / COLOUR / COULEUR / COLOR

SOBRE / TABLETOP /  
PLATEAU / SOBRE

ESTRUCTURA / STRUCTURE /  
STRUCTURE / ESTRUCTURA







22



metálico  
metal  
métallique  
metàllic

96

PESO **T4**  **9,16 kg**  
WEIGHT **T5**  **9,36 kg**  
POIDS **T6**  **9,56 kg**  
PES **T6**  **9,56 kg**

CANTIDAD DE EMBALAJE  
PACK QUANTITY  
QTÉ D'UNITÉS PAR CARTON  
QUANTITAT D'EMBALATGE



3

ES

Mesa con estructura tubular metálica y sobre compacto en fibras MDF. Pintada de poliéster de epoxy gris, RAL 9006.

Uso de herrajes con seguridad activa para evitar la manipulación por parte de los niños.

EN

Table with metal tubular frame and MDF tabletop. It is painted with epoxy-polyester aluminum color RAL 9006.

All fittings are designed for its correct use and resistance. Use of fittings with active safety to avoid children's manipulation.

FR

Table avec structure tubulaire métallique et plateau en MDF. Peinée avec peinture de polyester d'epoxy blanche couleur RAL 9006.

Toute le ferrure a été étudiée pour une correcte utilisation et résistance.

CAT

Taula amb estructura tubular metàl·lica i sobre compacte blanc de fibres MDF. Pintada d'epoxy-polièster de color alumini RAL 9006.

Ús de ferramenta amb seguretat activa per a evitar la manipulació per part dels nens.



**Sobre compacto de MDF**  
Compact MDF tabletop  
Tableau compact de MDF  
Sobre compacte de MDF



**Pata niveladora**  
Leveled legs  
Réglage du pied  
Peu nivellador



**Sobre abatible**  
Folding tabletop  
Plateau à abatant  
Sobre abatible



**Cajón de plástico**  
Plastic drawer  
Tiroir en plastique  
Calaix de plàstic  
36 x 30 x 10,5 cm

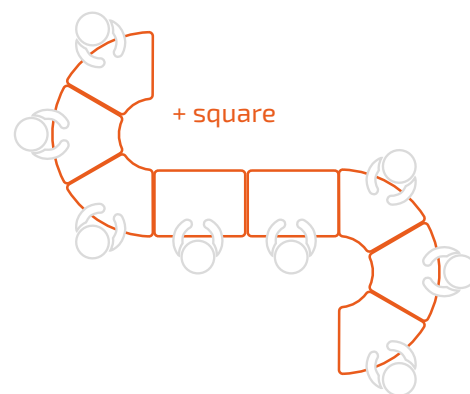
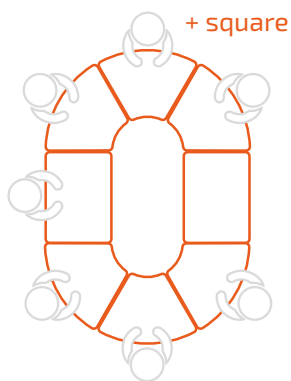
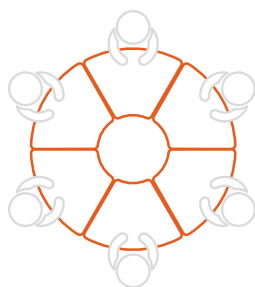
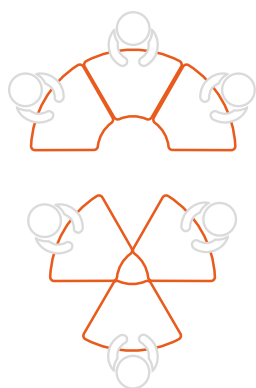

Tallas según la normativa europea UNE-EN 1729-1

Size according to European regulation UNE-EN 1729-1

Taille selon la norme européenne UNE-EN 1729-1

Talles segons la normativa europea UNE-EN 1729-1

TALLA SIZE TAILLE TALLA	EDAD AGE AGE EDAT	ALTURA HEIGHT HAUTEUR ALÇADA	ALTURA ASIENTO CHAIR HEIGHT HAUTEUR SIÈGE ALÇADA SEIENT	ALTURA MESA TABLE HEIGHT HAUTEUR TABLE ALÇADA TAULA
0	1-2	80-95 cm	21 cm	40 cm
1	2-3	93-116 cm	26 cm	46 cm
2	3-4	108-121 cm	30 cm	52 cm
3	4-6	119-142 cm	34 cm	59 cm
4	6-8	133-159 cm	38 cm	65 cm
5	8-10	146-176 cm	42 cm	70 cm
6	+12	159-188 cm	46 cm	77 cm
8*	+8	+146 cm	80 cm	100 cm

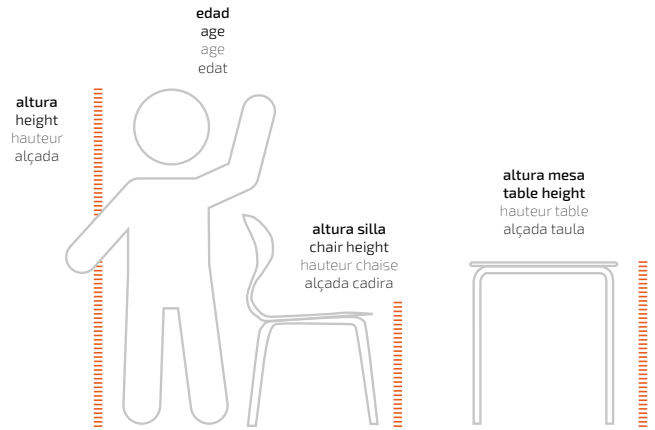

\*Equivalencia UNE-EN 1729-1 a dimensiones talla 5 para mesas de trabajo de pie.

\*Equivalence UNE-EN 1729-1 size 5 dimensions for tables to work standing up.

\*Équivalence UNE-EN 1729-1 aux dimensions 5 pour les tables de travail debout.

\*Equivalència UNE-EN 1729-1 a dimensions talla 5 per a taules per treball dempeus.

ES

Nuestros productos estan  
diseñados y fabricados según  
las normativas de aplicación  
correspondientes.

Relación de normas aplicables:

Sillas y mesas para centros  
educativos. UNE EN 1729-1: 07 /  
UNE EN 1729-2: 07.

Dimensiones, requisitos de  
seguridad y métodos de ensayo.

Según especificaciones UNE  
56.843: 01 mobiliario.

UNE - EN 71-3: 94 - Migración  
elementos metálicos.



CALIDAD CERTIFICADA  
CERTIFIED QUALITY  
QUALITÉ CERTIFIÉE  
QUALITAT CERTIFICADA

ASSOCIATED N°01646

**AIDIMA**  
FURNITURE, WOOD AND PACKAGING  
TECHNOLOGY INSTITUTE



**OXFAM**  
International

MIRPLAY COLABORA CON LA ONG  
MIRPLAY COLLABORATES WITH NGO  
MIRPLAY PARTICIPE À L'ONG  
MIRPLAY COL·LABORA AMB L'ONG